High Precision Pressure Transmitter

Model : P125 (Circular Connector)
P126 (DIN Connector)
P127 (Flying Leads)
P128 (General Head)



Advantages

- High precision pressure transmitter for industrial applications
- All stainless steel 316 construction
- Measuring ranges from 0.1 to 350kgf/cm²
- Advanced piezoresistive silicon measuring cell
- Excellent accuracy and long term stability
- 300% proof pressure
- Various choice of electrical connection

Applications

The transmitters can be used for a wide range of applications in process control, automatic machinery and hydraulic or pneumatic system design.

- Standard hydraulic and pneumatic equipments
- Machine tools and automatic machinery
- Flow control
- Oil and off-shore industry
- Equipments for chemical and petrochemical industry
- Engine monitoring and control
- Fire fighting equipments and braking systems for railway



P125



P126



P127



P128

Descriptions

P120 series pressure transmitter is a signal conditioned media-isolated high precision pressure transmitter that can be used for a wide variety of applications. The transmitter has a water resistant, stainless steel housing for complete protection from harsh environments. Its 4~20mA current output is ideal for remote monitoring of both primary and secondary process variables. It has been designed as an advanced device for measuring pressure of gases and liquids in industrial applications. It is extremely versatile and suitable for measuring dynamic or static pressure. The transmitters are available as absolute and relative pressure types with either 2-wire current or 3-wire voltage output.

The pressure to be measured acts through thin corrosion resistant stainless steel 316L diaphragm on a silicon measuring element. The pressure transmitting medium is silicon oil. The measuring element contains diffused piezoresistive resistors which are connected into a Wheatstone bridge. The output signal of this bridge is temperature compensated and converted into a standardized current or voltage output signal.

Specification

Input				
Technology	Piezoresistive silicon pressure sensor			
Pressure ranges	0~0.1 to 0~350kgf/cm ² relative pressure 0~1 to 350kgf/cm ² absolute pressure			
Pressure reference	Gauge, absolute, vacuum and compound			
Overload	3x full scale without damage			
Output				
	Unamplified		Unamplified	
Electrical connection type	2-wire technique		3 or 4-wire technique	
Full scale output signal	20mA	±0.05%	5V	±0.05%
Zero measured output	4mA	±0.03%	1V	±0.03%
	Other signals available on request			
Electrical Specification				
Excitation voltage	24V DC(12~36V DC)			
Load resistance max @ 24V	500Ω at 24V			
Influence of excitation	0.01% FSO/V			
Power ripple	≤500mV P-P			
Reverse polarity	Protected			
Shock resistance	No change in performance after 10Gs for 11ms			
Vibration	0.1G (1m/s/s) maximum			
Response time(10~90%)	≤2 milliseconds			
Adjustment	±10% FSO/zero and span			
Performance Specification				
Accuracy	≤ ±0.25% FSO			
Non-linearity	±0.100% FSO typical			
Repeatability	±0.015% FSO typical			
Pressure hysteresis	±0.010% FSO typical			
Long term stability	±0.3% FSO over 6 month			
Cutoff frequency(-3 d B)	≤2KHz			
Reference temperature	35 °C			
Operating temperature range	-40~125 °C			
Compensated temperature range	0~82 °C			
Thermal sensitivity shift	≤ ±0.2% FSO in reference to 35°C typical			
Thermal zero shift	≤ ±0.2% FSO in reference to 35°C typical			
Thermal hysteresis	≤ ±0.1% FSO in reference to 35°C typical			
Physical Specification				
Process connection	PT1/4 , PT3/8 , PT1/2 male thread			
	PF1/4 , PF3/8 , PF1/2 male thread			
	Female thread & other connections available on request			
Process media	Gases and liquids compatible with			
Materials wetted by process	Diaphragm : Stainless steel 316L			
	Housing : Stainless steel 316			
	Gasket O-ring : Viton (HNBR, CSM, etc.)			
Enclosure rating	IP65			
Influence of mounting position	Not critical but 0.1 to 0.5bar should be mounted vertically			
Weight	Approx. (270g)			
Options	Cooling Fin			
	Siphon tube			

- Note :
- ① Cable version : 1.5m standard length, 4-wire, shielded with integral vent tube
 - ② Vented gauge units must breathe dry, non - corrosive gases.
 - ③ Connector version is vented through the removed pin, cable versions are vented through a vent tube inside the cable sleeve

System connection for 2-wire transmitter

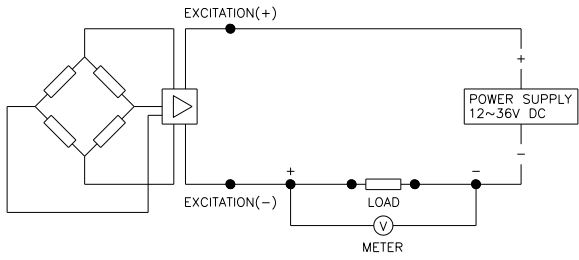

System connection for 3-wire transmitter

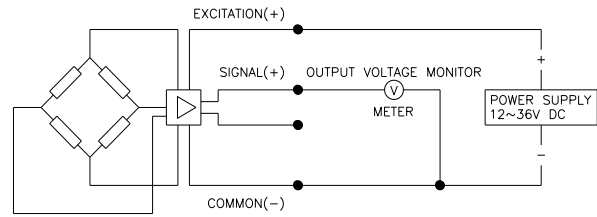

Dimension (mm)

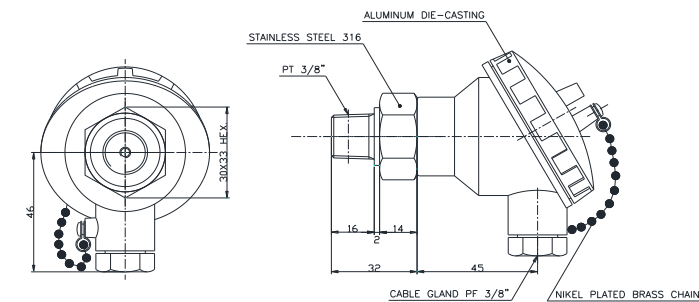
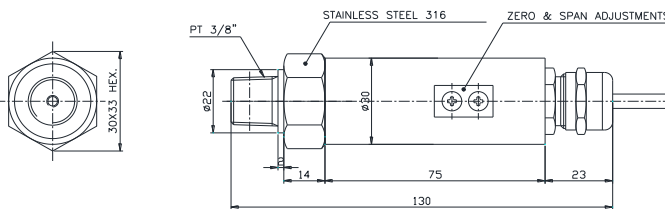
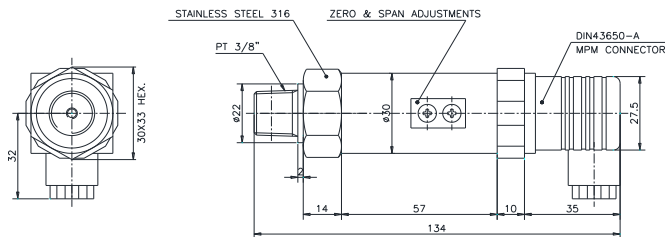
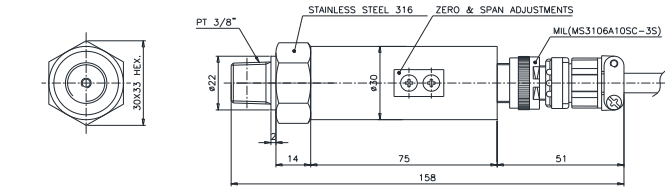

Electrical connection

E : Excitation

S : Signal

C : Common

Circular connector

System Color	2-Wire	3-Wire	4-Wire
Red	E +	E +	E +
Black	E -	C -	E -
Green		S +	S +
White			S -
GND	Shielded	Shielded	Shielded

DIN connector

System Color	2-Wire	3-Wire	4-Wire
1	E +	E +	E +
2	E -	C -	E -
3		S +	S +
GND	Shielded	Shielded	S -

Flying Lead

System Color	2-Wire	3-Wire	4-Wire
Red	E +	E +	E +
Black	E -	C -	E -
Green		S +	S +
White			S -
GND	Shielded	Shielded	Shielded

General head

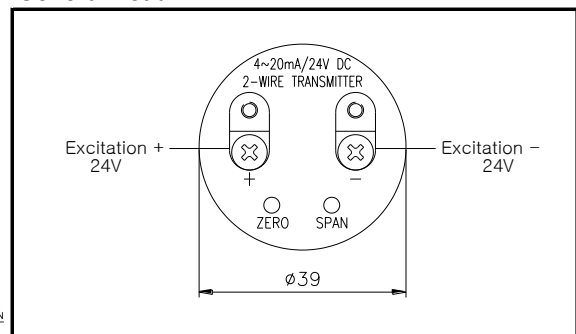

Ordering Information

High Precision Pressure Transmitter

1. Base model

P125												Circular Connector
P126												DIN Connector
P127												Flying lead(1.5m cable)
P128												General Head

2. Pressure reference

R												Relative pressure
A												Absolute pressure

3. Process connection type "1"

M												Male thread
F												Female thread

4. Process connection type "2"

T												PT thread as standard
N												NPT thread
F												PF thread
X												Other process connections available on request

5. Process connection size

1												1/4"
2												3/8"
3												1/2"
X												Other units available on request

6. Accuracy

H												±0.25% F.S.O
---	--	--	--	--	--	--	--	--	--	--	--	--------------

7. Measuring range

01												0 ~ 0.1 kg/cm ²
02												0 ~ 0.2
03												0 ~ 0.5
04												0 ~ 1
05												0 ~ 2
06												0 ~ 5
07												0 ~ 10
08												0 ~ 20
09												0 ~ 35
10												0 ~ 50
11												0 ~ 100
12												0 ~ 200
13												0 ~ 350
xx												Other calibration ranges available on request

8. Unit

M												Calibration in mmH ₂ O
K												Calibration in kgf/cm ²
A												Calibration in Mpa
B												Calibration in bar
P												Calibration in psi
X												Other units available on request

9. Output signal / Electrical connection type

A1												4~20mA, DC, 2-wire output
A2												4~20mA, DC, 4-wire output
B1												1~5V, DC, 3-wire output
B2												0~5V, DC, 3-wire output (Only available P126 and P127)
B3												0~10V, DC, 3-wire output (Only available P126 and P127)

10. Option

N												None options
C												Cooling Fin
S												Siphon tube
X												Other accessories available on request

P125	R	M	T	2	H	01	K	A1	N	Sample ordering code		
------	---	---	---	---	---	----	---	----	---	----------------------	--	--

Specifications subject to change without notice

