

Differential pressure gauge with diaphragm element

Model: P660 series

Spec. sheet no. PD06-04

Service intended

P660 gauge series are differential pressure gauge is designed to measure differential pressure from 4 kPa to 2.5 MPa at Max. working pressure of 10, 25 MPa. A set of two stainless steel diaphragm mounted on a force balance allows direct reading of the actual differential pressure.



Nominal diameter

100 and 160 mm

Accuracy

±1.0 % of full scale
±1.6 % of full scale

Scale range (MPa, kPa, bar, mbar)

0 ~ 4 kPa to 0 ~ 40 kPa
Flange size / DN 140, Max. static / 10 and 25 MPa
0 ~ 60 kPa to 0 ~ 2.5 MPa
Flange size / DN80, Max. static / 25 MPa

Working temperature

Ambient : -20 ~ 65 °C
Fluid : Max. 100 °C

Degree of protection

EN60529/IEC529/IP67

Temperature effect

Accuracy at temperature above and below the reference temperature (20 °C) will be effected by approximately ±0.5 % per 10 °C of full scale



Standard features

Pressure connection (Flange)

Stainless steel (316L SS)

Element

Diaphragm
316 Ti : Flange size / DN140 (Low side and high side)
316L SS : Flange size / DN80 (Low side)
/ Duratherm 600 (High side)

Case and cover

Stainless steel (304SS)

Window

Safety glass

Dial

White aluminium with black graduations

Filling liquid for differential cell

Silicone oil

Pointer

Black painted aluminium alloy (Zero adjustable)

Process connection

¼" NPT(F)
½" NPT(F) at 3-way and 5-way manifold valve

Standard accessories

Mounting bracket for 2" pipe
mounting with silver gray finished steel

Option

- Remote seal - Not available with less than 40 kPa of differential pressure range
- Mounting bracket with 316SS for 2" pipe
- 3-way and 5-way manifold valve
- 3-way and 5-way manifold valve (Monel)

WISE[®]

| P661.P662_01

1. Base model

- P661** Differential pressure gauge
(Max.working pressure : 10 and 25 MPa) (DN 140)
- P662** Differential pressure gauge
(Max.working pressure : 25 MPa) (DN 80)

2. Nominal diameter (mm)

- 4 100
- 6 160

3. Type of mounting

- D Bottom connection, mounting bracket for 2" pipe
- L Bottom connection, flush, case center mounting plate

4. Accuracy

- 3 ±1.0 % of full scale (Optional)
- 4 ±1.6 % of full scale (Standard)

5. Process connection

- C ¼" NPT(F)
- E ½" NPT(F), only at 3-way and 5-way manifold valve

6. Mounting bracket

- D Standard bracket
- E 304SS mounting bracket
- F 316SS mounting bracket
- W Wall mounting bracket (316SS)
- N None

7. Unit

- H bar
- I MPa
- J kPa
- S mbar

8. Range

XXX Refer to pressure unit and range table

9. Element and flange material

	Element	Flange
1	Standard	316L SS
2	Standard	Monel

10. Option

- 0 None
- 1 Manifold valve
- 6 Silicone filling
- 7 Manifold valve and silicone filling

1	2	3	4	5	6	7	8	9	10
P661	6	D	4	E	D	H	XXX	1	0

Sample
ordering code

P661 : Type of mounting

Code:(D) P661

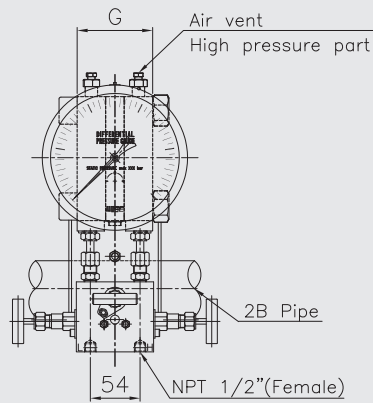

Static(MPa)	G
10	83.5
25	118.5

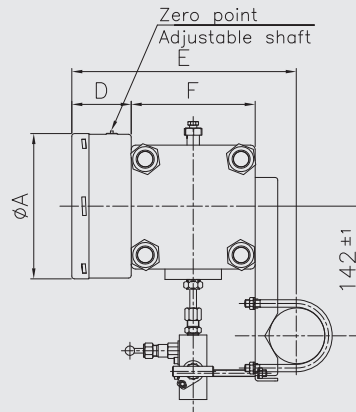

Model	Dial size	Pressure range	dimensions (mm)±2			
			A	D	E	F
P661	φ100	Less than 40kPa	101.3	63	245	137
	φ160		160.6	65	248	

P662 : Type of mounting (1/2)

Code:(D) P662

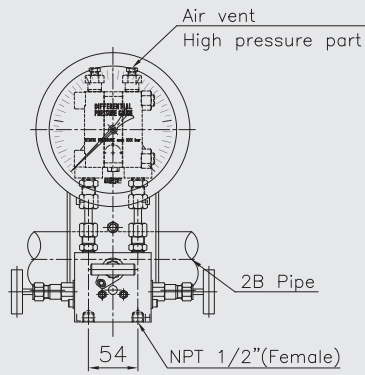

Code:(D) P662(Remote seal)

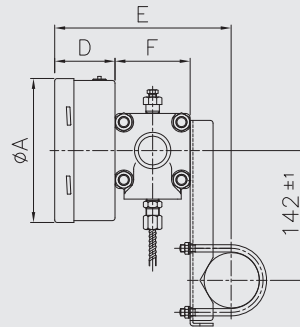
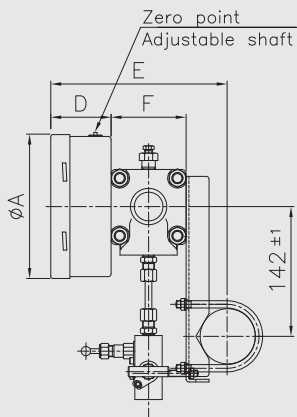
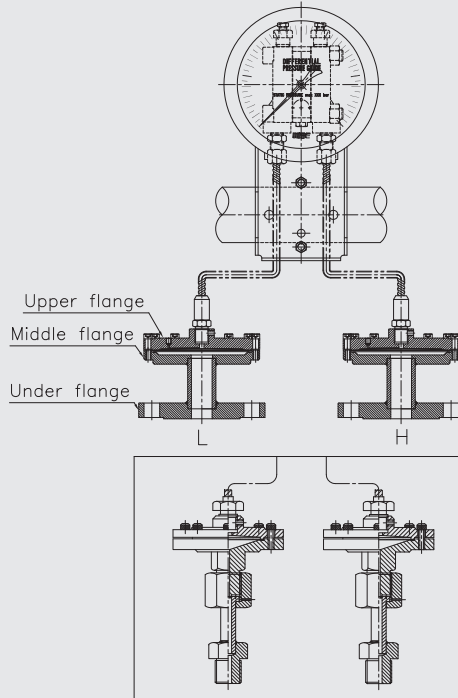

Model	Dial size	Pressure range	dimensions (mm)±2			
			A	D	E	F
P662	∅100	Over 40kPa	101.3	63	194	86
	∅160		160.6	65	197	

P662 : Type of mounting (2/2)

Code:(L) P662

Code:(L) P662(Remote seal)

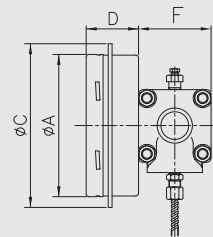
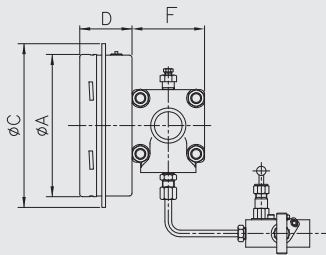
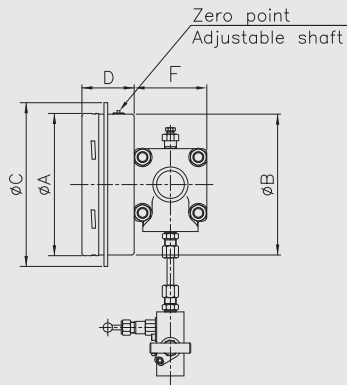
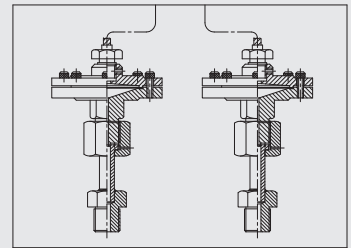
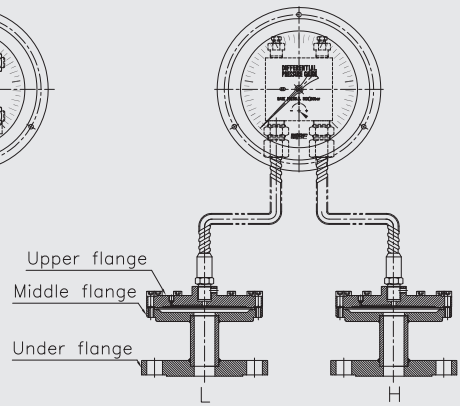
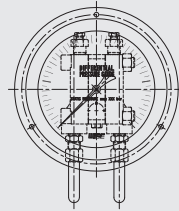
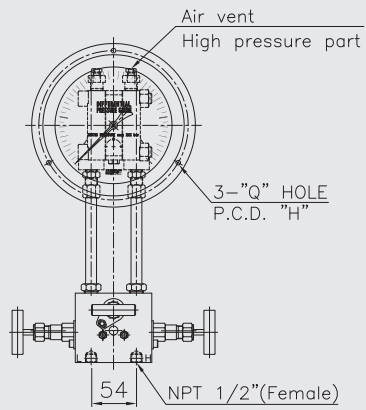

Model	Dial size	Pressure range	dimensions (mm) ± 2					
			A	B	C	D	F	H
P662	$\phi 100$	Over 40kPa	101.3	99	132	63	86	116
	$\phi 160$		160.6	159	192	65		175.5~176.5

Pressure unit and range table

Range and code	Unit and code					
	J : kPa	S : mbar	H : bar	I : MPa	Flange size	Max. static pressure
464	0 ~ 4	0 ~ 40	X	X	DN 140	10 and 25 MPa
466	0 ~ 6	0 ~ 60	X	X		
469	0 ~ 10	0 ~ 100	X	X		
517	0 ~ 25	0 ~ 250	X	X		
121	0 ~ 40	0 ~ 400	X	X		
131	0 ~ 60	0 ~ 600	X	X		
041	0 ~ 100	X	0 ~ 1	0 ~ 0.1	DN 80	25 MPa
133	0 ~ 160	X	0 ~ 1.6	0 ~ 0.16		
042	0 ~ 200	X	0 ~ 2	0 ~ 0.2		
134	0 ~ 250	X	0 ~ 2.5	0 ~ 0.25		
044	0 ~ 400	X	0 ~ 4	0 ~ 0.4		
045	0 ~ 600	X	0 ~ 6	0 ~ 0.6		
047	0 ~ 1,000	X	0 ~ 10	0 ~ 1		
143	X	X	0 ~ 16	0 ~ 1.6		
052	X	X	0 ~ 25	0 ~ 2.5		

X : Not available