

Temperature recorder (Case compensation system)

Model : T930

Spec. sheet no. TD09-01

Service intended

This recorder provides a single pen and 200 mm circular chart recorder with the function of measurement and recording. It is suitable for hazardous environment such as gas or chemical process.

Nominal diameter

246 (W) x 271 mm (H)

Accuracy

±2.0 % of full scale

Measuring system (SAMA class IIIB)

Organic gas : 0 ~ 200 °C
Inert gas : -200 ~ 700 °C

Working range

Maximum scale value



Standard features

Location of stem and mounting

Bottom connection, surface, case mounting

Case

ALDC

Cover

ALDC

Capillary

Capillary : 1.6/0.2 mm, 316SS
Armored tube : 7.5/5.5 mm, 304SS

Window

Acrylic resin

Chart drive

Spring wound type
24 hours or 168 hours (7 days) rotation

Chart paper

200 mm circular

Mounting

Surface

Stem

8.0, 10.0 and 12.0 mm
316SS and 316L SS

Stem, process connection

3/8", 1/2", 3/4" PT, NPT and PF

1. Base model

T930 Temperature recorder

2. Nominal diameter (mm)

9 246 (W) x 271 (H)

3. Type of mounting

B Bottom connection, surface, case mounting plate

4. Stem material

1 316SS

2 316L SS

5. Stem, process connection

A None

D 5/8"

E 1/2"

F 3/4"

6. Stem connection type (CF: Compression fitting)

A None

E CF + PT

F CF + NPT

G CF + PF

H MT + PT (Movable thread)

I MT + NPT (Movable thread)

J MT + PF (Movable thread)

7. Stem outer diameter (mm)

2 8.0

3 10.0

4 12.0

Z Other

8. Range

XXX Refer to scale range table

9. Capillary length (m)

A Direct mounting type

P 2

Q 3

S 5

V 8

X 10

Z Other

10. Accessories

0 None

1 Thermowell

1	2	3	4	5	6	7	8	9	10
T930	9	B	1	E	C	3	XXX	Q	1

Sample
ordering code

T930 : Type of mounting

Code B

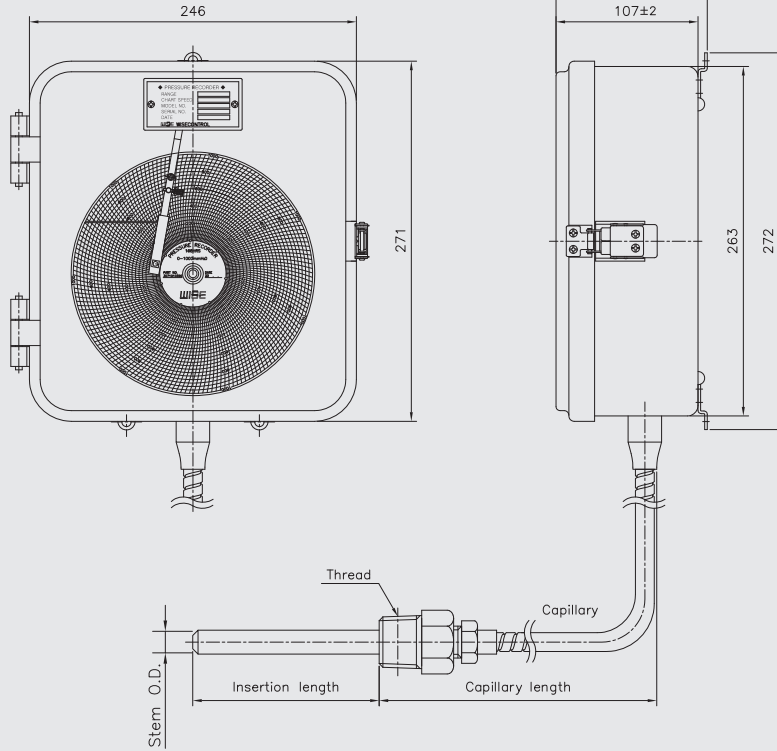

Code B

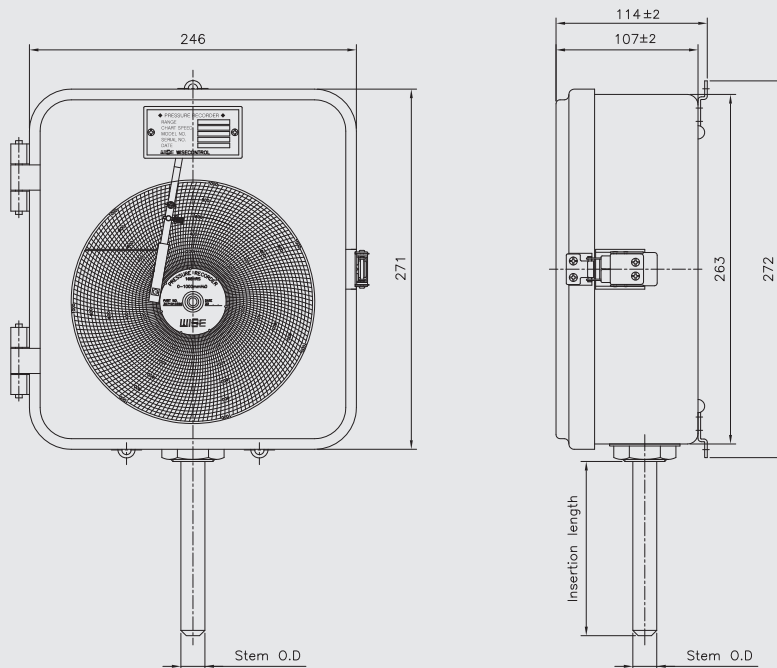

Scale ranges

Code	Scale range (°C)	Scale spacing(°C)	Minimum stem length (mm)			Standard stem length (mm)		
			8.0	10.0	12.0	8.0	10.0	12.0
032	-50 ~ 50	2	100	85	65	200	130	100
037	-50 ~ 100	5	100	88	65	200	130	100
054	-30 ~ 50	2	100	85	65	200	130	100
059	-30 ~ 100	2	100	85	65	200	130	100
061	-30 ~ 120	5	100	85	65	200	130	100
069	-20 ~ 50	2	100	85	65	200	130	100
074	-20 ~ 100	2	100	85	65	200	130	100
079	-20 ~ 150	5	100	85	65	200	130	100
084	-10 ~ 50	1	100	85	65	200	130	100
099	0 ~ 50	1	100	85	65	200	130	100
100	0 ~ 60	1	100	85	65	200	130	100
101	0 ~ 70	2	100	85	65	200	130	100
102	0 ~ 80	2	100	85	65	200	130	100
104	0 ~ 100	2	100	85	65	200	130	100
106	0 ~ 120	2	100	85	65	200	130	100
109	0 ~ 150	5	100	85	65	200	130	100
114	0 ~ 200	5	100	85	65	200	130	100
119	0 ~ 250	5	100	85	65	200	130	100
124	0 ~ 300	5	100	85	65	200	130	100
129	0 ~ 350	5	100	85	65	200	130	100
134	0 ~ 400	10	100	85	65	200	130	100
144	0 ~ 500	10	100	85	65	200	130	100
154	0 ~ 600	10	100	85	65	200	130	100
164	0 ~ 700	10	100	85	65	200	130	100

* 0 ~ 700 °C/Special range

Insertion length

Code	1	2	3	4	5	6	7	8	9	A	B	C
Length (mm)	50	60	70	80	100	120	130	150	175	200	225	250

Code	D	E	F	G	H	J	K	L	M	N	P
Length (mm)	275	300	350	375	400	450	500	550	1,000	1,500	2,000