



testo 312 - 2/3

Instruction manual



Introduction	2
Initial operation	3
Warnings	3
Safety instructions	3
Diagram of instrument	4
Operating the instrument	5
Measurement example	6
Switching on instrument	6
Differential pressure measurement	7
Fine pressure/Draught measurement	8
Connection options	9
Pre-test / Main test	10
Service ability test	11
Setting alarm limits	12
Setting date/time	13
Setting timer for printout	15
Setting number of printouts	16
Changing the units	17
Maintenance	18
Changing rechargeable battery or battery	18
Error messages	18
Technical data	19
Ordering data	20
Pressure transducer (Accessories)	21

Introduction

Dear Customer

You have made the right decision by purchasing **testo 312**.

testo 312 is designed to adjust and maintain gas heating systems.

Thousands of customers buy our high standard products every year. There are at least 7 good reasons for doing so.

- 1) Cost-performance ratio. Reliable quality at a fair price.
- 2) Extended warranty times of up to 3 years - depending on instrument!
- 3) We have the ideal solutions for your measuring tasks based on our expert experience gained over 40 years.
- 4) Our high quality standard is confirmed by the ISO 9001 certificate.
- 5) Of course, our instruments carry the CE symbol required by the EU.
- 6) Calibration certificates for all relevant parameters. Seminars, advice and calibration on location.
- 7) Our after-sales service. Contact us for more information.

Instrument conforms with 2004/108/EEC



Function check/Leak check

Prior to commencing any testing the complete measuring system (instrument, probe and hoses) should be checked for leaks

Temperature influence on the leak test

During any leak tests the ambient temperature must remain constant to obtain valid data.

Instrument should only be used by trained personnel.

Always adhere to any system safety instructions and never use the equipment in an explosive environment.

Function test

for both pressure nipples

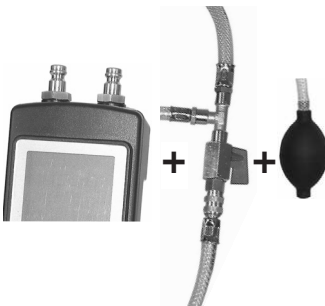

No reading in display?
Send instrument for service.

Safety instructions

Under normal operating conditions gas will not escape from the instrument when connected to the gas pipe / system under test.

The instrument is not designed to operate while wet, or in an environment of condensing humidity

The instrument should only be used in the conditions and for the purposes for which it was constructed. Please take particular note of the safety instructions and the technical data.

The instrument should only be used in the operation and measurement ranges specified in the technical data.

Capacity display



Voltage >7.2 V

Life of rechargeable battery: approx. 5 h

Life of battery: approx. 15 h

(at an ambient temperature of 20°C)

Low Bat



Flashing symbol, voltage: <7.2 V

Life of rechargeable battery: approx. 15 min.

Life of battery: approx. 45 min.

If the rechargeable battery voltage drops below 6.7 V automatic switch-off follows as protection against total discharge.

Initial operation

Diagram of instrument

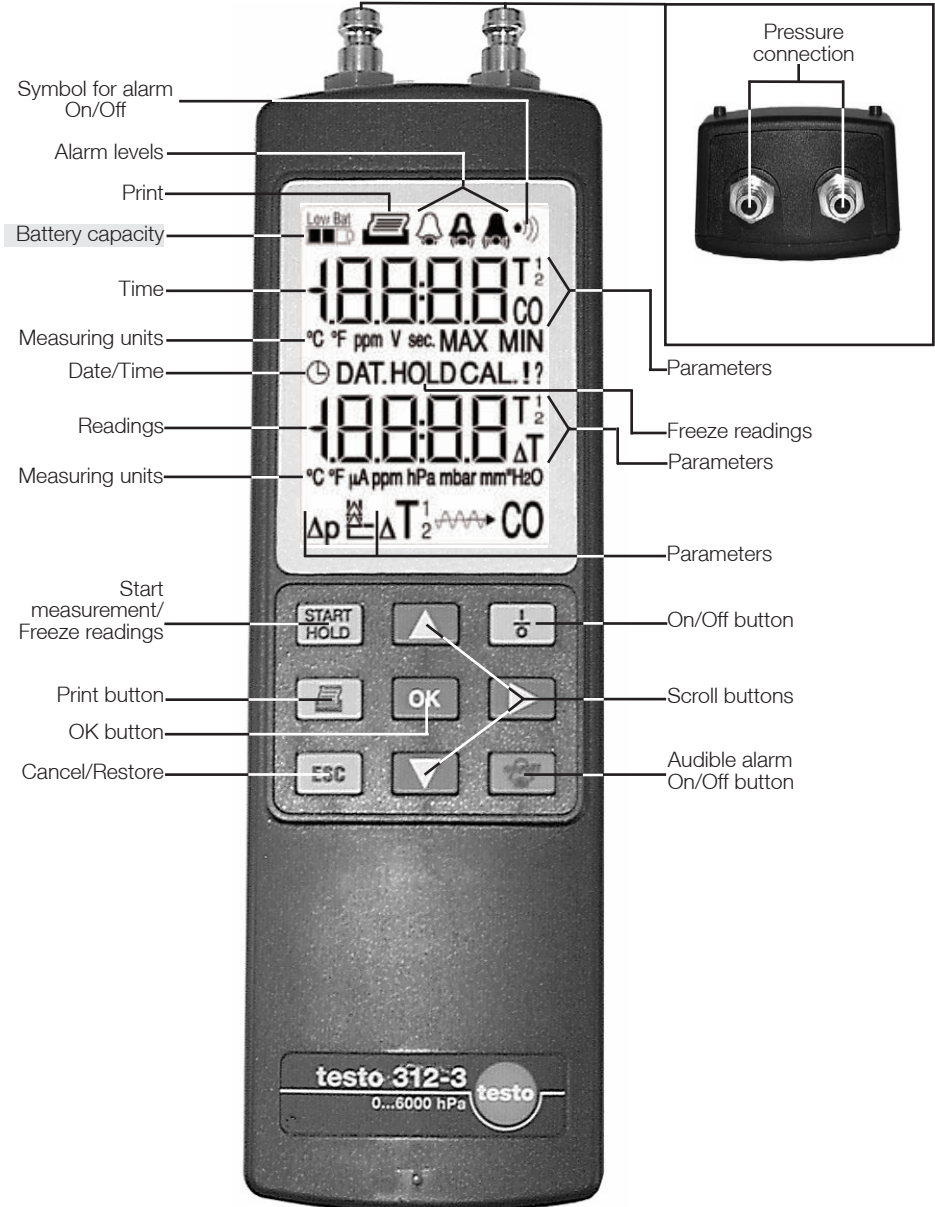

Operating the instrument

Keypad

- Scrolling buttons

Using the **arrow buttons**  /  you can scroll between the parameters, digits in date/time and the alarm limits can be set.

- Selection button

In the date/time and alarm limits menu, access to the variable parameters is via the arrow button pointing to the right .

The units can also be changed. The parameters are set using the up  and down  buttons.

- Printing

All of the saved readings can be printed on the printer by pressing **Print** .

- I/O button

The instrument is switched on or off via the **I/O button** . The display switches off automatically after 5 seconds once the instrument is switched off. This can be prevented by pressing any button. The instrument then goes to the Δp measurement menu.

The readings in the display are usually lost when the instrument is switched off.

- Cancel button

The **Cancel**  button is used to cancel a selected process or to leave a sub-menu.

- OK button

The changed parameters are saved by pressing .

- START/HOLD button

Start measurement by pressing .

The displayed readings are frozen by pressing  again.

- Alarm on/off button

Switches audible signal on or off.

Measurement example: testo 312-2/-3

Switching on instrument

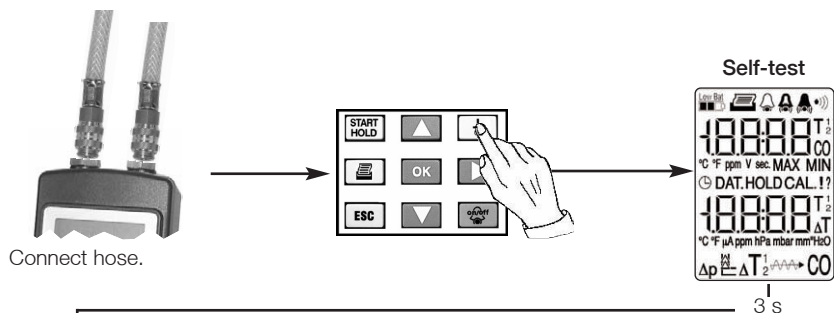

Display for battery capacity / instrument version



OK

Instrument version



3 s

3 s

Self-test

Press $\frac{1}{0}$ button. Displays all segments for approx. 3 seconds.

Battery capacity / Instrument version (2 digit)

Displays battery/rechargeable battery voltage and instrument version for approx. 3 seconds.

Instrument version (3 digit)

If the **OK** button is pressed within 3 seconds the version number is shown in 3 digits. You then go to the measurement menu.

Measurement menu



5 s

Instrument switches off

Measurement example: testo 312-2/-3

Differential pressure measurement

testo 312-2: Range: 0 to 200 hPa. Resolution: 0.1 hPa

testo 312-3: Range: 0 to 6000 hPa. Resolution: 1 hPa

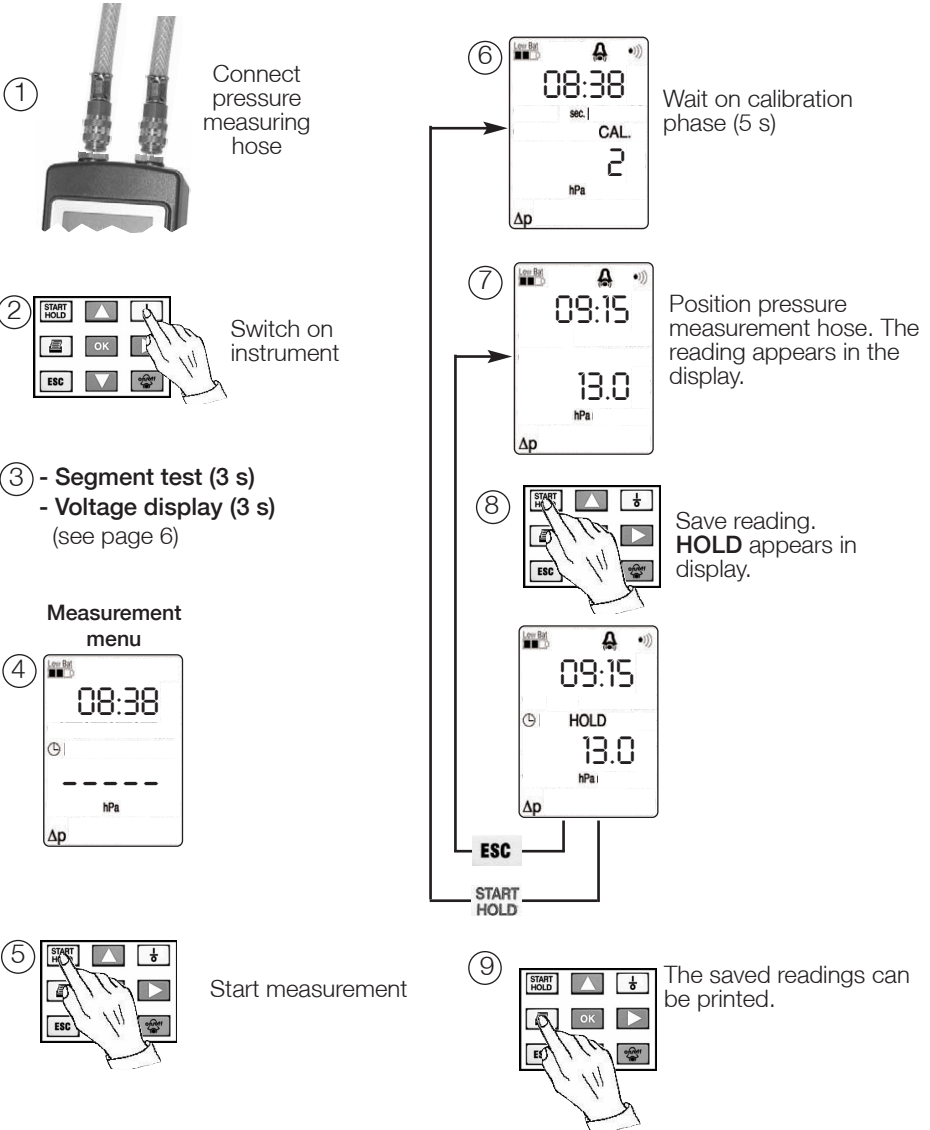

Measurement example: testo 312-2

Fine pressure / Draught measurement

testo 312-2: ΔP range 0 to 40 hPa. Resolution: 0.01 hPa
testo 312-3: ΔP range 0 to 300 hPa. Resolution: 0.1 hPa

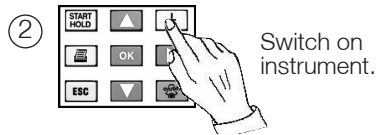

- ③
- Segment test (3 s)
 - Voltage display (3 s)
(See page 6)
 - Function check
(See page 7)

Measurement menu

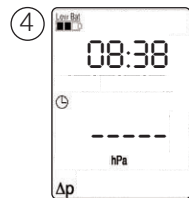

Measurement menu

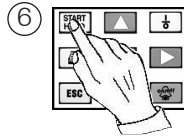
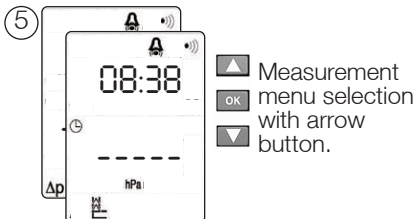

Start measurement.



Wait on calibration phase (5 s)



Position probe in flue gas duct. The reading appears in the display.

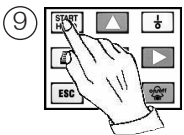

Save reading. **HOLD** appears in the display

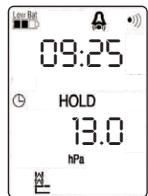

ESC
START HOLD

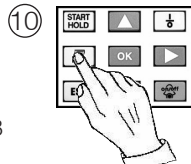

The saved readings can be printed.

Measurement example: testo 312-2/-3

Connection options



Single-pipe counter cap

Conical test plugs

High pressure stepped plugs

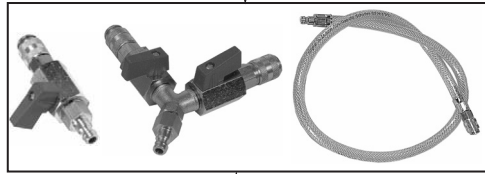

Mini valve

Junction

Connection hose

Pressure drop set

Pressure transducer (for liquid substances); Refer to instructions on page 22.

- Suitable for:
- Pre-test
 - Main test
 - Testing service ability
 - Checking pressure in water pipelines



Connect pressure transducer directly to instrument. Do not use extensions. Apply pressure. Remove pressure from pipe before detaching pressure transducer from instrument.



Observe maximum pressure range. Positive pressure destroys the instrument.

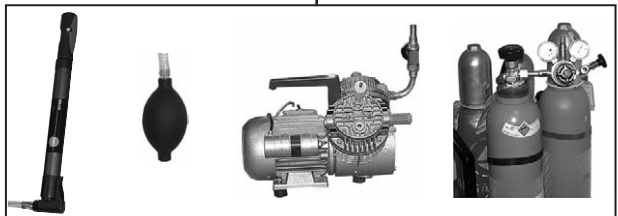

Testing pump

Balloon pump

Compressor

Inert gas

Measurement example: testo 312-2/-3

Pre-test / Main test

①



Example

Insert single-pipe counter cap and tighten.

Carry out function test! Gas should not get into the instrument when carrying out measurements on gas pipes.

Pressure drop

The complete measuring system (instrument, probe, hoses and connections) should be checked for a drop in pressure e.g. using pressure drop test set by attaching the single-valve stop.



Preliminary test

Pipes are checked, without fittings, with a test pressure of 1 bar. This pressure should not fall during the 10-minute duration of the test.

Main test

Pipes are checked, with fittings, with a test pressure of 110 mbar. This pressure should not fall during the 10-minute duration of the test. The measuring instrument should be able to recognise a drop in pressure of 0.1 mbar.

②



Ensure connection is correct.

Connect pressure drop set and **testo 312**.

③

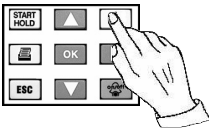

Switch on instrument.

Start measurement with **START/HOLD** button.

⑤



Manual printout triggers an automatic printout after 10 minutes.

④



Build up test pressure



⑥

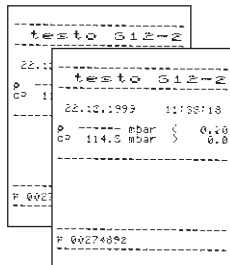

Compare printouts OK/not OK

Measurement example: testo 312-2/-3

Service ability test

①



Insert single-pipe counter cap and tighten.

②



Ensure connection is correct.

Connect pressure drop set and **testo 312**.

③

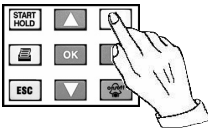

Switch on instrument.

Start measurement with START/HOLD button.

④



Build up test pressure.

⑤



Printout of initial pressure

⑥



Audible signal after 1 min

Carry out function test! Gas should not get into the instrument when carrying out measurements on gas pipes.

Pressure drop

The complete measuring system (instrument, probe, hoses and connections) should be checked for a drop in pressure e.g. using pressure drop test set by attaching the single-valve stop.



Checking if fit for use

The pipe is pumped with air up to the respective test pressure and the drop in pressure in one minute is measured.

⑦

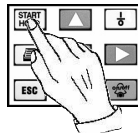

Freeze reading with START/HOLD

⑧



Prints reading

⑨

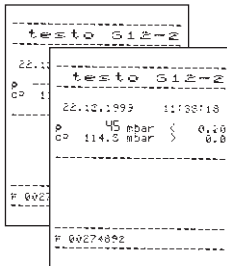

Determines Δp

⑩



Use slide rule to determine what measure to take

Setting alarm limits



①

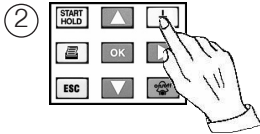

②

Switch on instrument.

- ③ - Segment test (3 s)
- Voltage display (3 s)
(See page 6)

Measurement menu



④

Measurement menu selection via arrow button.

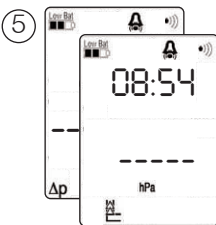

⑤

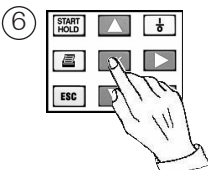

⑥

Differential pressure (testo 312-2/-3), draught (testo 312-2)

⑦
Differential pressure

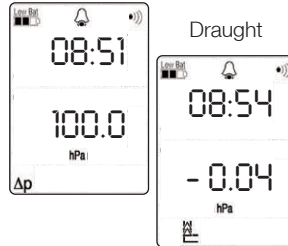

- Increase or decrease alarm limits via arrow buttons.
- OK
-

After the measurement, the flashing is a sign that an alarm limit is set and was reached.

Note:

If the alarm limit has a value of 0.00 or 0.0, the alarm of the corresponding alarm limit is switched off. The dP or draught alarm is inactivated following initialisation. Alarm symbols do not appear on the display. The alarm is deactivated by the manufacturer i.e. the alarm limit is set at 0.00 or 0.0. Press the alarm button once the alarm limit is changed. The symbol is visible.

Alarm setting range

	testo 312-2	testo 312-3
ΔP	0 to 200	0 to 6000
	0 to -40	0 to 300

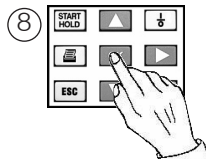

⑧

Go automatically to measurement menu.

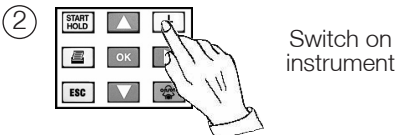

- ③ - Segment test (3 s)
- Voltage display (3 s)
(See page 6)

Measurement menu



- ⑤ Press and buttons simultaneously.



Setting the hour

- Increase or decrease digit with arrow buttons.
 Return to measurement menu via OK

- ⑥ Press button.



Setting minutes

- Increase or decrease digit with arrow buttons. Press OK button to return to measurement menu

- ⑦ Press button



Setting the day

- Increase or decrease digit with arrow buttons. Press OK button to return to measurement menu

- ⑧ Press  button



Setting the month



Increase or decrease digit with arrow buttons. Press OK button to return to measurement menu.

Note:

The date display can be changed from Day/Month (EUR) to Month/Day (US) by pressing



- ⑨ Press  button.



Setting the year



Increase or decrease digit with arrow buttons. Press OK button to return to measurement menu.

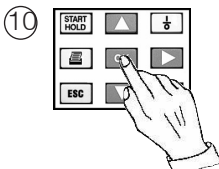

Save selection with OK button. Return to measurement menu selection.

Note

You can leave the menu by pressing ESC but the changes are not carried out.

Setting timer for printout

①



②

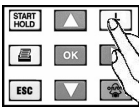

Switch on instrument

- ③ - Segment test (3 sec.)
- Voltage display (3 sec.)

(See page 6)

④



- ⑤ Press **OK** button 2 sec.

⑥

Timer setting



▲ Increase or reduce value using arrow buttons.
OK
▼

⑦

Press **▶** button.

Timer setting



▲ Increase or reduce value using arrow buttons.
OK
▼

⑧

Press **OK** button.

Alarm limit display

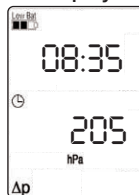

⑨

Press **OK** button. Return to measurement menu.

Setting number of printouts

①



②

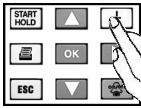

Switch on instrument

③

- Segment test (3 sec.)
 - Voltage display (3 sec.)
- (See page 6)

④

Measurement menu



⑤

- Press **OK** button 2 sec.

⑥

Display timer

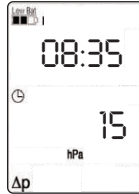

⑦

- Press button

Set number of printouts



- Increase or reduce number using arrow buttons.
- OK**
-

⑧

- Press **OK** button

Timer display

⑨

- Press **OK** button

Alarm limit display

⑩

- Press **OK** button. Return to measurement menu.

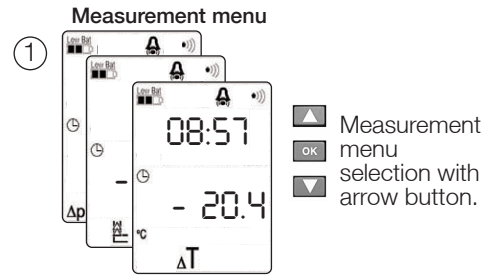

② Press  button

③ Select units by pressing 

Differential pressure measurement

hPa, mbar, mmH₂O, inchH₂O

Draught measurement

hPa, mbar, mmH₂O, inchH₂O (**testo 312-2 only**)

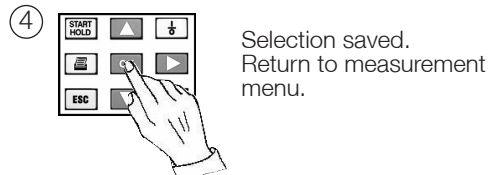

You can leave the menu by pressing **ESC** but the changes are not made.

Maintenance

Changing the rechargeable battery or battery

Remove rechargeable batteries/batteries if the instrument is not used for a longer period of time. If the battery cells leak in the instrument, return instrument to factory to be cleaned and checked.
Only the rechargeable batteries/batteries specified in the technical data should be used.

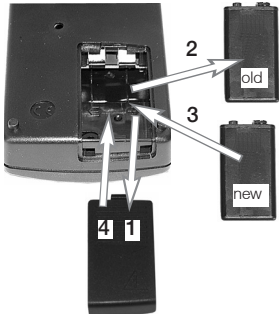

! Switch off instrument and disconnect from all measuring circuits before changing the rechargeable battery or battery.
Date and time are saved when the instrument is switched off.

Remove empty/defect rechargeable batteries or empty batteries from the battery compartment and replace with new ones.

! Observe correct polarisation of rechargeable batteries or batteries.
Instrument should only be used if the battery compartment cover is closed.

Error messages

Phase	Symbol	Cause
General	Low Bat is flashing	Power to instrument is too low. If the battery voltage drops below 6.7 volt, the instrument switches off automatically.
	T in top line is flash 	Non-permitted ambient temperature Adapt to ambient temperature.
	The message Exxx appears in the bottom line	Send instrument for service.
	-- -- -- --	Pressure sensor is overloaded.

If we were unable to answer your question, please contact your distributor or Testo Customer Service. For contact data, see back of this document or web page www.testo.com/service-contact

General Technical data for testo 312-2 and testo 312-3

Storage temperature:	-20 to +60 °C
Operation temperature:	+5 to +45 °C
Dimensions:	215mm x 68mm x 47mm
Weight:	Approx. 400 g

Differential pressure measurement

testo 312-2		
	$\frac{P_1}{P_2}$	ΔP
Measuring range*	±40 hPa	±200 hPa
Accuracy**	<3.00 hPa ±0.03 hPa >3.00 hPa ±1.5% of m.v.	±0.5 hPa (0 to 50 hPa) ±1,5% of m.v. (>50 hPa)
Resolution	±0.01 hPa	±0.1 hPa
Alarm limit	-0.01 to -40 hPa	0.1 to 200 hPa
Adjustment step	0.01 hPa	0.1 hPa
Alarm display	Audible and optical	
Max. overload	1 bar	

testo 312-3		
Measuring range*	±300 hPa	±6000 hPa
Accuracy**	±0.5 hPa <50 hPa ±1.5% of m.v. ≥ 50 hPa	±4 hPa <400 hPa ±2% of m.v. 400-2000 hPa ±4% of m.v. >2000 hPa
Resolution	±0.1 hPa	±1 hPa
Alarm limit	0.1 to 300 hPa	1 to 6000 hPa
Adjustment step	0.1 hPa	1 hPa
Alarm display	Acoustic and optical	
Max. overload	8 bar	

Draught (testo 312-2 only)

testo 312-2	
Measuring range*	±40 hPa
Accuracy**	<3.00 hPa ±0.03 hPa >3.00 hPa ±1.5% of m.v.
Resolution	±0.01 hPa
Alarm limit	-0.01 to -40 hPa
Adjustment step	0.01 hPa
Alarm display	Audible and optical
Max. overload	1 bar

* Measuring instrument is temperature-compensated

** Accuracies do not apply in connection with pressure transducers
0554.3159 and 0554.3168

Warranty

Instrument:	2 years
Probes:	1 year
Accessories	6 months
Printer	1 year (excluding printing mechanism)

Ordering data

testo 312

Description	Part no.
Instrument	
testo 312-2 compact pressure gauge with instruction manual and battery	0632.0313
testo 312-3 compact pressure gauge with instruction manual and battery	0632.0314
Accessories	
Testo printer , prints measurement data with location, date and time	0554.0547
Spare rolls for printer	0554.0569
Rechargeable battery for printer (4 off)	0515.3120
Rechargeable battery 9V for instrument	0515.0025
Recharger for 9 V rechargeable battery	0554.0025
Recharger for printer	0554.0110
Pressure set with flue probe	0554.3150
TopSafe , indestructible protection case	0516.0443
Case	0516.0191
Service case	0516.3120
Pressure drop test set, 200 mbar	0554.3153
Test pump for pressure drop test set	0554.3157
Single-pipe counter cap	0554.3156
Two-valve junction	0554.3161
Single-valve stop	0554.3162
Connection hose LW6	0554.3158
Conical test plug 16-32mm	0554.3151
Conical test plug 24-44mm	0554.3155
Conical test plug 35-65mm	0554.3152
High pressure stepped plug 3/8" and 3/4"	0554.3163
High pressure stepped plug 1/2" and 1"	0554.3164
Complete high pressure set with case	0554.3160
Pressure transducer for liquid substances, 1 to 6000 mbar	0554.3159
Pressure transducer for liquid substances, 1 to 1000 mbar	0554.3168
System case	0554.3165
Leak detection spray	0554.3166
Slide rule	0554.3169
Test system set	0563.0314

Pressure transducer (Accessories)

Instructions

Normal use

The pressure transducer protects the **testo 312** measuring instrument from moisture and high temperatures: measures vapour and water pressure.

Connection P



Connection A

Measuring



Do not use an extension cable between the pressure transducer and the instrument.

- 1 Connect connection **A** of the pressure transducer directly to the instrument (+).
- 2 Switch on instrument.
- 3 Press “Start” and wait for calibration phase (5s).
- 4 Connect connection **P** of the pressure transducer directly to the control pressure pipe.



Observe maximum pressure range of instrument and the pressure transducer used!

- 5 Apply pressure to pipe.
- 6 Take readings.
- 7 Press “Hold”.
- 8 Remove pressure from pipe.
- 9 Disconnect pressure transducer from instrument.

Technical data

Connection size:1/8” plug-in connection
Size

(Height/Diameter):33mm/64.8mm

Weight:175g

Housing material:Aluminium

Pressure range:0-1bar (0554.3168)

.....0-6bar (0554.3159)

Pressure loss:0 to 6% of reading

Diaphragm:Temperature resistant to 120°C,

.....oil resisting

Overload:2bar (0554.3168)

.....8bar (0554.3159)



testo AG

Postfach 11 40, 79849 Lenzkirch

Testo-Straße 1, 79853 Lenzkirch

Telefon: (07653) 681-0

Fax: (07653) 681-100

E-Mail: info@testo.de

Internet: <http://www.testo.com>